



Product Information
Version 2.0

ZEISS Primo Star

Robust, User-Friendly, and Affordable:
The Right Microscope for Educators and Students Alike



We make it visible.

Show Students the Secrets of Specimens under a Microscope. Watch Them Learn!

- › In Brief
- › The Advantages
- › The Applications
- › The System
- › Technology and Details
- › Service

You place very specific demands on the microscopes you use in your classes. And rightly so. That's why ZEISS brings you Primo Star, a microscope especially suited to educational settings. As a classroom microscope Primo Star is designed for long-term use and extreme durability. And so easy to use that students will spend their time learning, not fiddling with technology.

Connect your classrooms: Use Primo Star with its integrated 5 megapixel HD streaming camera in conjunction with Labscope, the iPad imaging app from ZEISS, to network the microscopes in your classroom. This will make teaching easier for you and help students learn quickly and more effectively.

Primo Star incorporates 160 years of ZEISS leadership in optical microscopy, specially adapted to the most sophisticated environmental conditions of today's classroom settings and laboratory work.



Simpler. More Intelligent. More Integrated.

- › In Brief
- › **The Advantages**
- › The Applications
- › The System
- › Technology and Details
- › Service

Successful Teaching and Enthusiastic Students

Primo Star delivers everything that matters in an educational setting: the ability to view stained tissue sections, unstained cells in phase contrast, cross-sections of plant stems – and to analyze pathogens.

The Fixed-Köhler version of Primo Star comes with the Plan-ACHROMAT 100x/0.8 dry objective. Or you can work with the Full Köhler versions. Either way, Primo Star shows the intensity of illumination on both sides of the stand so you can keep an eye on all the microscopes in the room – even at a distance.

The Connected Classroom

Consider the advantages of having the camera integrated into the tube and a number of interface options. You can connect microscopes in your classroom to each other, using Labscope, the iPad imaging app from ZEISS. Then connect them in turn to HD monitors or projectors to share your images or videos with students. Or use the USB port for free access to the powerful imaging software ZEN lite. Or save your data directly to the integrated SD card. Give your students the full experience of mutual learning with brilliant images.

Clever Details for Greater Freedom

Primo Star's modern look is esthetically pleasing, but that's just the start: the sleek design houses an array of smart features. You can use either a 30-watt halogen bulb or energy-saving LED illumination with its stable color temperature and illumination intensity. The built-in carrying handle lets you move the microscope safely, for example, when storing it away. Use the handy battery supply unit in areas with fluctuating electricity or none at all. Add on the fluorescence tube and turn your Primo Star into a LED fluorescence microscope.



Your Insight into the Technology Behind It

- › In Brief
- › **The Advantages**
- › The Applications
- › The System
- › Technology and Details
- › Service

ZEISS Primo Star:

Beam Path of Transmitted Light

In microscopes using Köhler illumination only the area of the specimen being observed is illuminated, thus diffused light is minimized. At the same time, the illuminating light cone adjusts to the opening cone of the objective to make use of the numerical aperture of the optics. The tools used to achieve this are the field diaphragm and the condenser, which contains the aperture diaphragm. Adjusting the Köhler illumination, the field diaphragm is displayed on the sample using the condenser.

This diaphragm determines which part of the sample is illuminated. The aperture diaphragm is adjusted so that at least two-thirds of the objective pupil's diameter is illuminated. Thus, the illuminating light cone is adjusted to the objective's numeric aperture. After correctly setting the Köhler illumination, the illumination of the specimen as well as the contrast and resolution of the image will be perfectly harmonized.

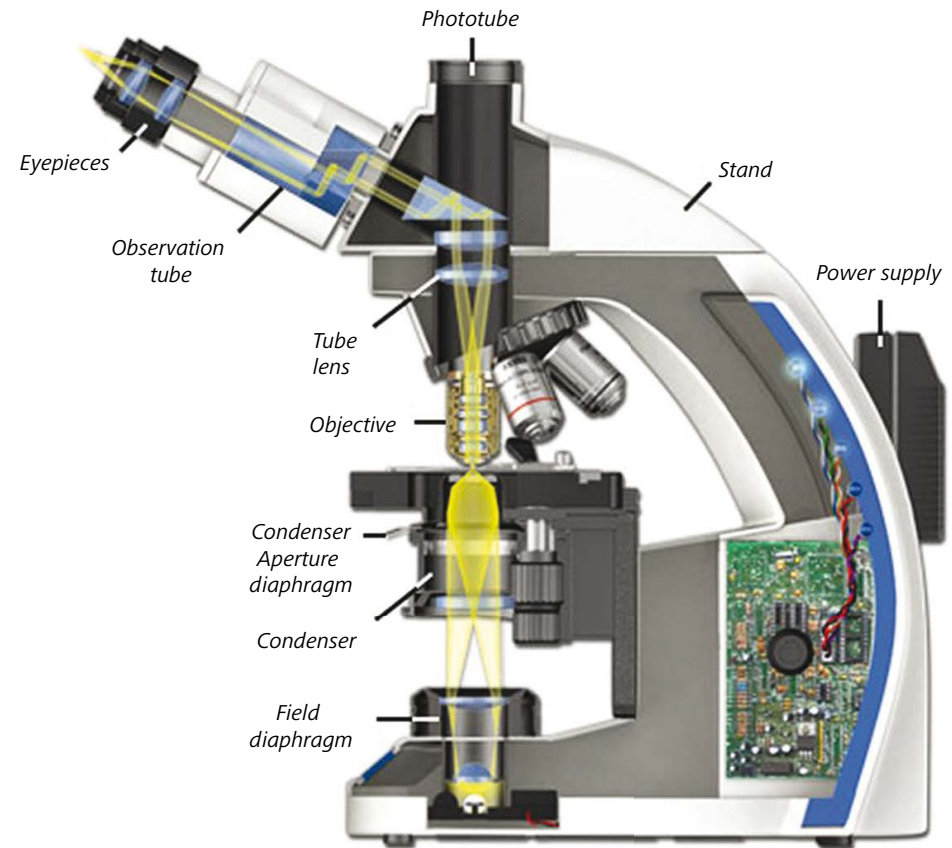

Optical beam path of ZEISS Primo Star

Expand Your Possibilities

- › In Brief
- › **The Advantages**
- › The Applications
- › The System
- › Technology and Details
- › Service

ZEISS Labscope –

Your Doorway to the Digital World

Use Labscope, the iPad imaging app from ZEISS, to display all the live images from your connected microscopes. Select any student's image with just one click. Record images and videos with the high resolution of 5 megapixels. You can annotate your images and, for example, measure distances. Then share your images, reports, and videos with others via email, social media or cloud services. With Labscope, you can save your images in the ZEN compatible .czi file format, which includes all metadata and a separate annotation layer. Or select the .jpg format to save space. Downloading Labscope is fast and easy from the Apple App Store – and it's 100% free.

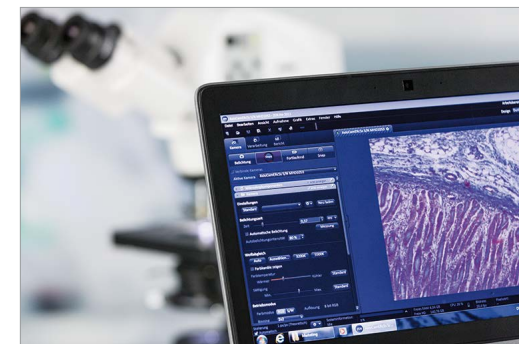

Tailored Precisely to Your Applications

- › In Brief
- › The Advantages
- › **The Applications**
- › The System
- › Technology and Details
- › Service

Typical applications, typical samples	Task	ZEISS Primo Star offers
Vocational and advanced training in:		
Biology	Unstained cells in phase contrast, such as the examination of oral mucosa; for example, extremely fine structures such as diatoms in darkfield	Fixed-Köhler versions Dry objective Anti-theft protection for objectives Transport handle Illumination intensity display
	Brightfield applications, such as determining the structure of a cell, analyzing plant cross-sections	Phase contrast: with this contrasting technique, you can view high-contrast images of unstained samples. You will be able to judge the cells' growth, morphology, and condition at a glance.
Human and veterinary medicine	Examining tissue samples and blood slides in the fields of anatomy, pathology, hematology, and zoology for the purpose of recognizing typical disease patterns	Oil immersion objectives: morphological examinations of bacteria cells are carried out in brightfield when studying microorganisms with an oil immersion objective.
Agricultural and environmental sciences	Studying diseases and pests on cultivated plants; epidemiology, disease development and the course of infection; diagnosis of pathogenic organisms and pests	Primo Star iLED: carry out fluorescence contrast examinations of samples stained with FITC and Auramine O.
Food science, microbiological training	Morphology of bacteria cells such as <i>Bacillus subtilis</i> , <i>Staphylococcus epidermidis</i> , <i>Micrococcus luteus</i> , <i>Escherichia coli</i>	
Medical professions, laboratory applications in schools and universities	Laboratory examinations of bodily fluids, tissues, and excretions, such as hematological examinations regarding cell morphology of blood and tissue cells, hemostaseological examinations (bleeding diathesis and/or thrombophilia), determining blood type	
Digital classroom	Connecting microscopes of the classroom and visualizing the images of the connected systems as overview; choosing single images and sharing them with other students	Primo Star with integrated HD camera and iPad imaging app Labscope: connect your classroom and discuss samples together.

ZEISS Primo Star at Work

- › In Brief
- › The Advantages
- › **The Applications**
- › The System
- › Technology and Details
- › Service

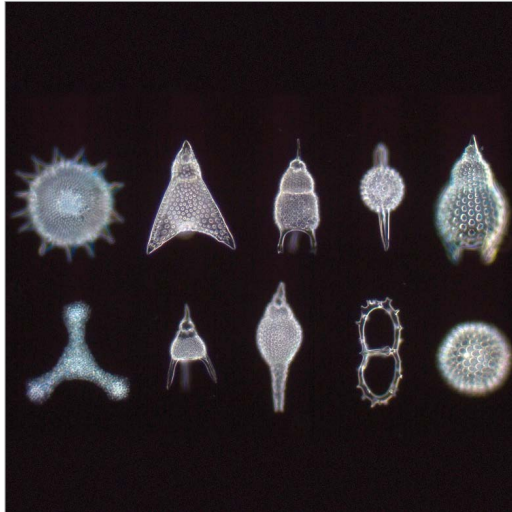

*Fossil radiolarian, annular darkfield,
Objective: Plan-ACHROMAT 40x/0.65*

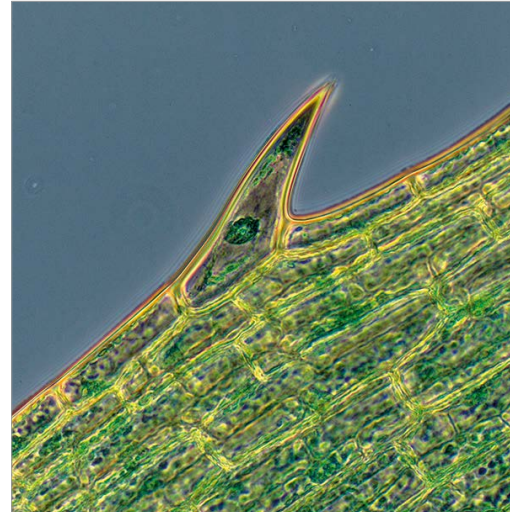

*Waterweed (Elodea), phase contrast,
Objective: Plan-ACHROMAT 40x/0.65*

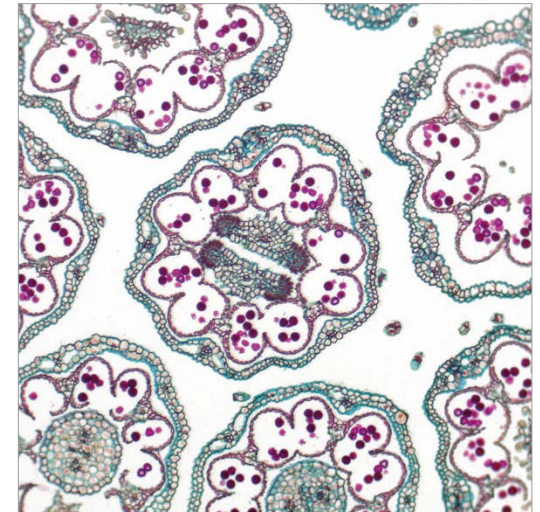

*Flower umbel of daisy (Bellis perennis), brightfield,
Objective: Plan-ACHROMAT 10x/0.25*

Your Flexible Choice of Components

- › In Brief
- › The Advantages
- › The Applications
- › **The System**
- › Technology and Details
- › Service



1 Microscope

- Primo Star (Fixed-Köhler)
- Primo Star (Full Köhler)
- Primo Star iLED with reflected light fluorescence illuminator

2 Objectives

- Plan-ACHROMAT 4x, 10x, 20x, 40x and 100x for brightfield, darkfield and phase contrast
- Plan-ACHROMAT 100x/0.8 dry objective
- Plan-ACHROMAT 4x, 10x, 20x, 40x and 100x, D=0 (without cover glass)

3 Illumination

Transmitted light:

- HAL 30 W (Halogen)
- LED 3 W
- Illuminating mirror

Reflected light:

- Reflected light fluorescence illuminator (455 nm, FS 67; 470 nm, FS 09)

4 Cameras

Recommended cameras:

- AxioCam ICc 5
- AxioCam 105 color (requires ZEN 2012 SP2)
- AxioCam ICc 1
- AxioCam ERc 5s
- Tube with integrated 5 megapixel HD streaming camera

5 Software

- ZEN lite
- iPad imaging app Labscope

6 Accessories

- Transport case
- Battery supply unit

Your Flexible Choice of Components

- › In Brief
- › The Advantages
- › The Applications
- › **The System**
- › Technology and Details
- › Service

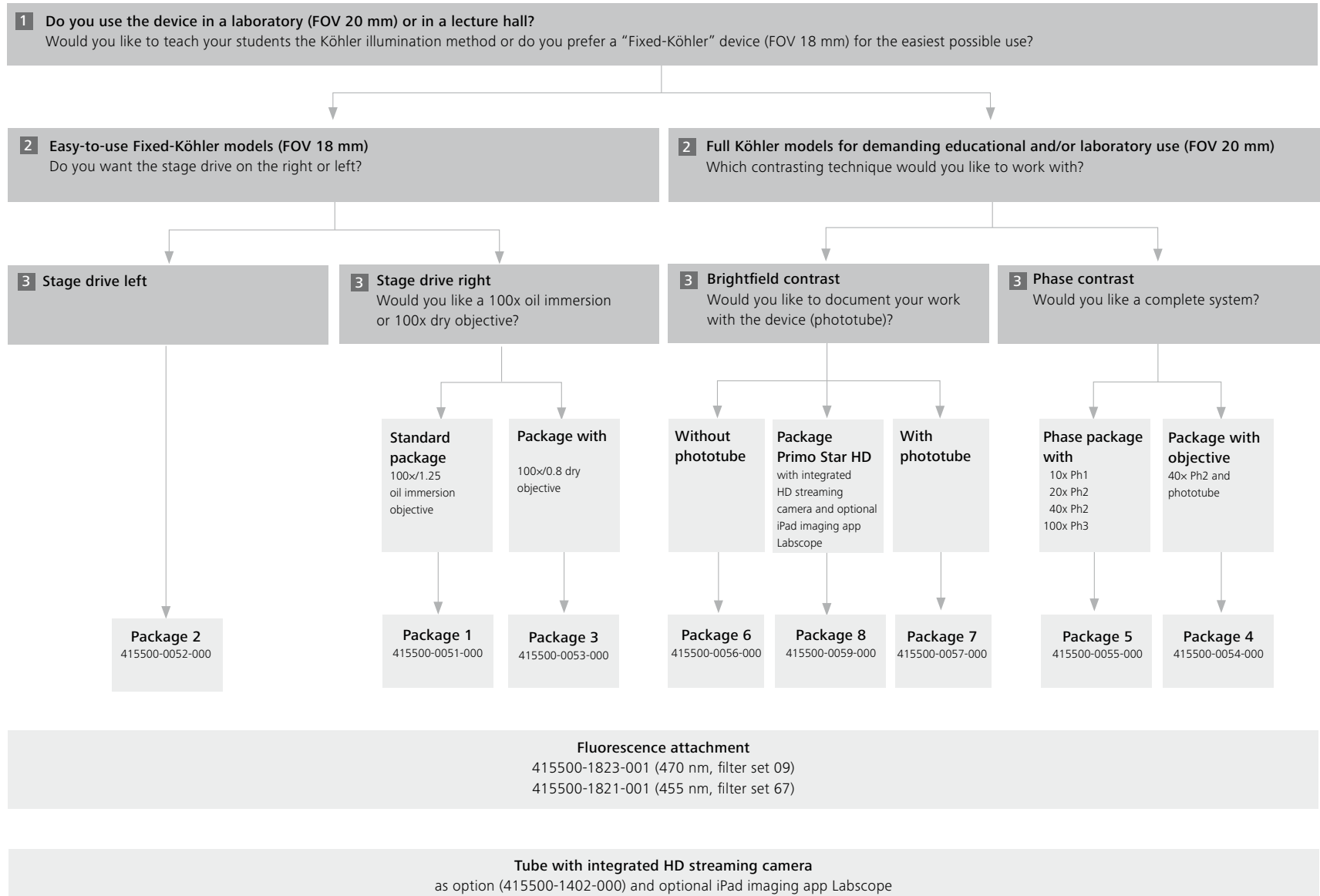

System Overview ZEISS Primo Star

- › In Brief
- › The Advantages
- › The Applications
- › The System
- › Technology and Details
- › Service

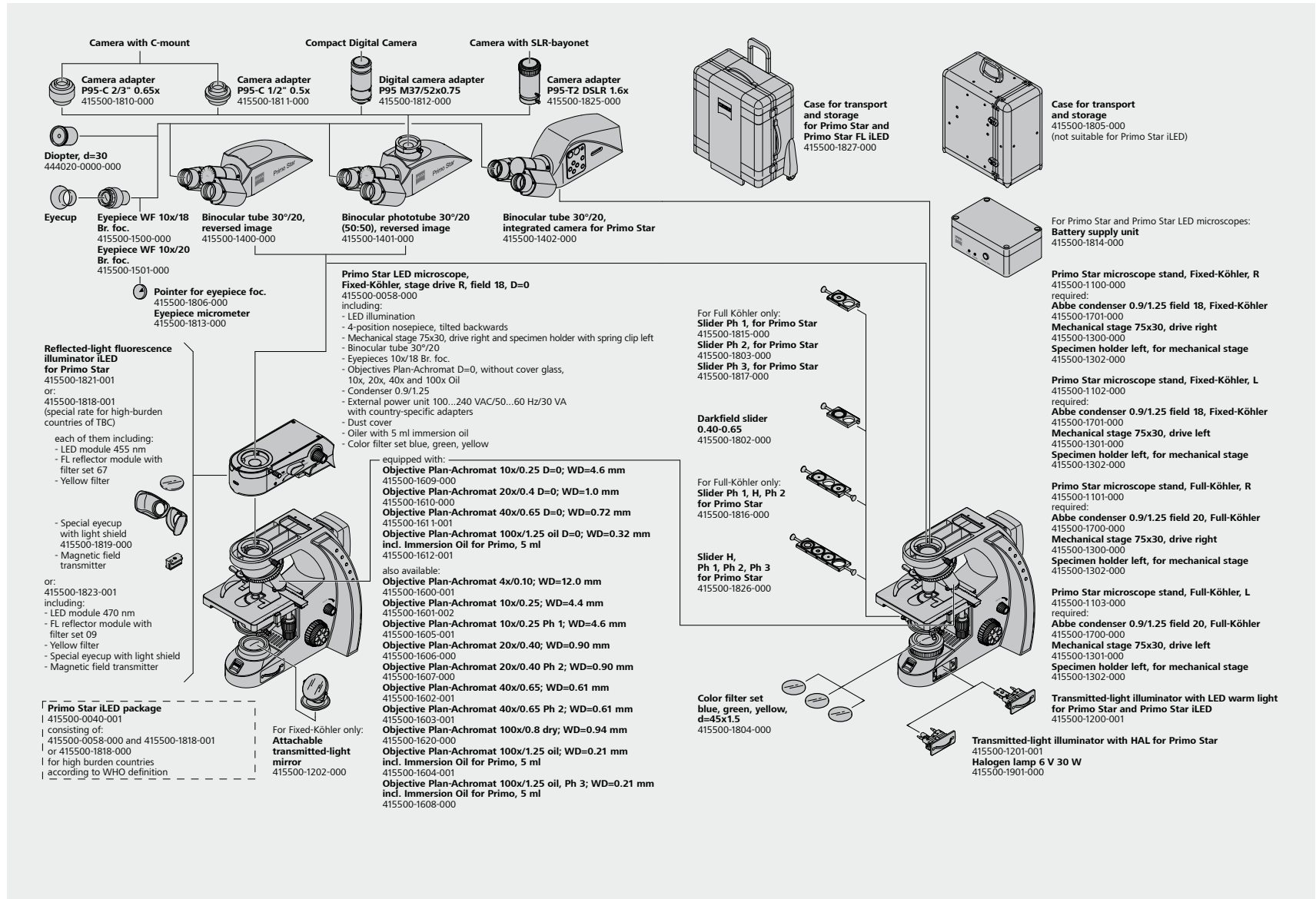

Technical Specifications

- › In Brief
- › The Advantages
- › The Applications
- › The System
- › **Technology and Details**
- › Service

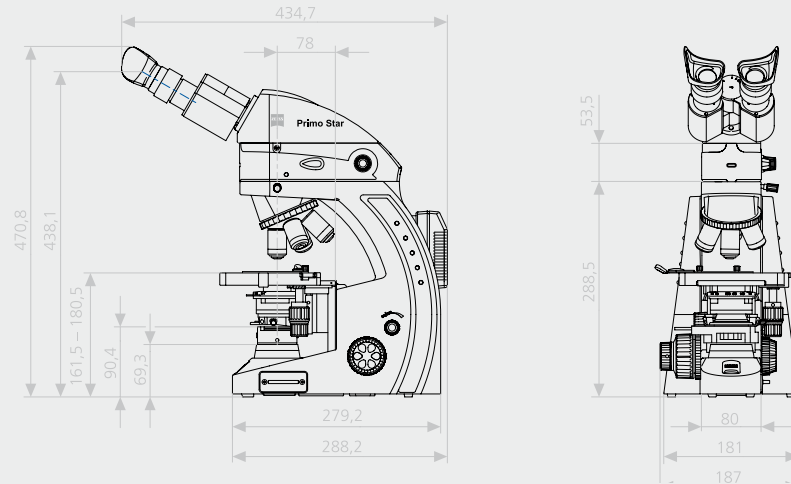

Dimensions (width x depth x height)

Stand with binocular tube	approx. 190 mm x 410 mm x 395 mm
Stand with phototube	approx. 190 mm x 425 mm x 395 mm
Stand with binocular tube 30°/20° and integrated HD IP camera for Primo Star	approx. 190 mm x 415 mm x 395 mm
With tube / phototube turned by 180°	approx. 190 mm x 375 mm x 395 mm
Stand with reflected-light fluorescence illuminator	approx. 190 mm x 410 mm x 449 mm

Weight

Primo Star with phototube	approx. 8.2 kg
Primo Star iLED with reflected-light fluorescence illuminator and phototube	approx. 9.6 kg
Primo Star with internal HD streaming camera	approx. 8.5 kg

Technical Specifications

- › In Brief
- › The Advantages
- › The Applications
- › The System
- › **Technology and Details**
- › Service

Ambient conditions	
Transportation (in packaging):	
Permissible ambient temperature	-40 °C to +70 °C
Storage:	
Permissible ambient temperature	+10 °C to +40 °C
Permissible air humidity (no condensation)	max. 75 % at 35 °C
Operation:	
Permissible ambient temperature	+10 °C to +40 °C
Permissible air humidity (no condensation)	max. 75 % at 35 °C
Atmospheric pressure	800 hPa to 1060 hPa
Altitude	max. 2000 m
Operating data	
Protection class	II
Protection type	IP20
Electrical safety	in compliance with DIN EN 61010-1 (IEC 61010-1) including CSA and UL directives
Pollution degree	2
Overvoltage category	II
Radio interference suppression	in accordance with EN 61326
Line voltage	100 to 240 V (±10 %) wide-range input power supply, i.e. voltage setting of the instrument need not be changed!
Line frequency	50 / 60 Hz
Power consumption	70 VA; secondary voltage of external power supply 12 V
Plug-in power unit output	12 V DC; max. 2.5 A
Microscope 12 V / 6 V DC	adjustable from 1.5 V to 6 V
LED class of complete device	3B

Technical Specifications

- › In Brief
- › The Advantages
- › The Applications
- › The System
- › **Technology and Details**
- › Service

Light sources	
Halogen lamp	HAL 6 V, 30 W
Adjustability of light source	continuous, from 1.5 to 6 V DC
Color temperature at 6 V	2800 K
Luminous flux	280 lm
Average service life	1000 h
Luminous area	1.5 x 3 mm
LED illumination	white light LED, peak wavelength 440 nm, LED class 2
Constant, brightness-independent color temperature of	3200 K
Homogeneous field illumination	20 mm diameter
Suitable for objectives with magnifications of	4x to 100x
Analogous brightness adjustment from	approx. 15 to 100 %
LED modules (reflected light fluorescence illuminator)	max. 40 mW, 365 - 625 nm; LED class 3B
Battery supply unit (accessory)	
Batteries	fuses according to IEC 127 T4.0 A/H
Type	mono-cell (D) - commercially available, NiCd or NiMH, 1.2 V
Capacity	minimum 5000 to max. 9000 mAh
Number per battery supply unit	5 batteries
Operational lifetime	several hours, depending on the capacity of the batteries

Technical Specifications

- › In Brief
- › The Advantages
- › The Applications
- › The System
- › **Technology and Details**
- › Service

Optical/mechanical data	
Stand with stage focusing	
With coarse focusing drive	45 mm/rev.
With fine focusing drive	0.5 mm/rev.
Total stage lift	15 mm
Objective change	manual via quadruple objective nosepiece
Objectives	infinity-corrected objective range with W 0.8 mounting thread
Eyepieces	
With field-of-view number 18	PL 10x/18 Br. foc.
With field-of-view number 20	PL 10x/20 Br. foc.
Specimen stage	
Dimensions (width x depth)	140 x 135 mm
Stage travel (X x Y)	75 x 30 mm
Coaxial drive	optionally right or left
Vernier scales	readable from the right
Specimen holder	with spring lever, left
Abbe condenser 0.9/1.25; Fixed-Köhler	for Vobj. 4x to 100x
Abbe condenser 0.9/1.25; Full Köhler	for Vobj. 4x to 100x
Binocular tube 30°/20	
Maximum field-of-view number	20
Interpupillary distance	adjustable from 48 to 75 mm
Tube angle	30°
Viewing height	380 to 415 mm
Viewing port	tube factor 1x
Binocular phototube 30°/20	
Maximum field-of-view number	20
Interpupillary distance	adjustable from 48 to 75 mm
Tube angle	30°
Viewing height	380 to 415 mm
Viewing port	tube factor 1x
Photo/video port	tube factor 1x, 60 mm mount
Invariable splitting ratio	50 % vis / 50 % doc

Technical Specifications

- › In Brief
- › The Advantages
- › The Applications
- › The System
- › **Technology and Details**
- › Service

Binocular tube 30°/20 with integrated HD IP camera for Primo Star

Maximum field-of-view number (eyepiece)	20
Captured field-of-view of the camera	11.4 mm x 8.56 mm (14.2 mm diagonal)
Interpupillary distance	adjustable from 48 to 75 mm
Tube angle	30°
Viewing height	380 mm to 415 mm
Invariable splitting ratio	50 % vis / 50 % doc
Optical adaption	0.5x
Illuminating mirror	with plane surface and spherical surface with $f' = 75$ mm

HD-CMOS-camera

Sensor specific data

Sensor	Micron MT9P031
Sensor size	1/2.5", 5.7 mm x 4.28 mm (7.1 mm diagonal)
Pixel size	2.2 μ m x 2.2 μ m
Sensor type	1/2.5" CMOS, color
Read-out mode	Progressive scan
Sensor pixel count (H x V), full frame	2560 x 1920 pixel active, 5 megapixel
Live image, movie	1920 x 1080 pixel, 30Fps (H264 max. 16 Mbits / s)
Spectral sensitivity (without IR filter)	400 nm to 700 nm

Signal-Processing / Interface specific data

Digitalization / Color depth	24 Bit, 3 x 8 Bit / pixel
Amplifying	0-18 dB
Interfaces	USB 2.0, Mini-USB-plug LAN via RJ 45 plug socket, 100 Mbit SD-card (Secure Digital) 1-32 GB, slot for SD and SDHC HDMI (1080p/30 or 720p/60)
Remote control	IR sensor
Duo LED	Power on and ready for capture (green); Recording (blinking green); Not ready (red); Error (blinking red)
Key matrix	White balance, Snap, Contrast, Brightness, Menu
Exposure time	10 μ s to 2 s

Technical Specifications

- › In Brief
- › The Advantages
- › The Applications
- › The System
- › **Technology and Details**
- › Service

General	
Power supply	Via USB hub or external power supply, 5 V DC, power consumption 5 W
Ambient conditions (operation)	+5 °C to +45 °C, max. 80 % relative humidity, no condensation
Operating data of power supply unit for binocular tube 30°/20 with integrated HD IP camera for Primo Star	
Protection class	II
Protection type	IP20
Electrical safety	Via USB hub or external power supply, 5 V DC, power consumption 5 W
Pollution degree	2
Overvoltage category	II
Radio interference suppression	in accordance with EN 61326-1 and EN 61326-2-6
Line voltage	100 to 240 V (±10 %) wide-range input power supply, i.e. voltage setting of the instrument need not be changed!
Line frequency	50 / 60 Hz
Power consumption plug-in power unit output	5 V DC, 1.0 A

Count on Service in the True Sense of the Word

- › In Brief
- › The Advantages
- › The Applications
- › The System
- › Technology and Details
- › **Service**

Because the ZEISS microscope system is one of your most important tools, we make sure it is always ready to perform. What's more, we'll see to it that you are employing all the options that get the best from your microscope. You can choose from a range of service products, each delivered by highly qualified ZEISS specialists who will support you long beyond the purchase of your system. Our aim is to enable you to experience those special moments that inspire your work.

Repair. Maintain. Optimize.

Attain maximum uptime with your microscope. A ZEISS Protect Service Agreement lets you budget for operating costs, all the while reducing costly downtime and achieving the best results through the improved performance of your system. Choose from service agreements designed to give you a range of options and control levels. We'll work with you to select the service program that addresses your system needs and usage requirements, in line with your organization's standard practices.

Our service on-demand also brings you distinct advantages. ZEISS service staff will analyze issues at hand and resolve them – whether using remote maintenance software or working on site.

Enhance Your Microscope System.

Your ZEISS microscope system is designed for a variety of updates: open interfaces allow you to maintain a high technological level at all times. As a result you'll work more efficiently now, while extending the productive lifetime of your microscope as new update possibilities come on stream.

Please note that our service products are always being adjusted to meet market needs and maybe be subject to change.



Profit from the optimized performance of your microscope system with services from ZEISS – now and for years to come.

>> www.zeiss.com/microservice



Carl Zeiss Microscopy GmbH
07745 Jena, Germany
microscopy@zeiss.com
www.zeiss.com/primostar



Instruments
info@ctk-instruments.com
www.ctk-instruments.com
866-464-1005



We make it visible.